

DEOMATIC

Pièces détachées adaptables pour: LAMBER

Adaptables pour Lamber

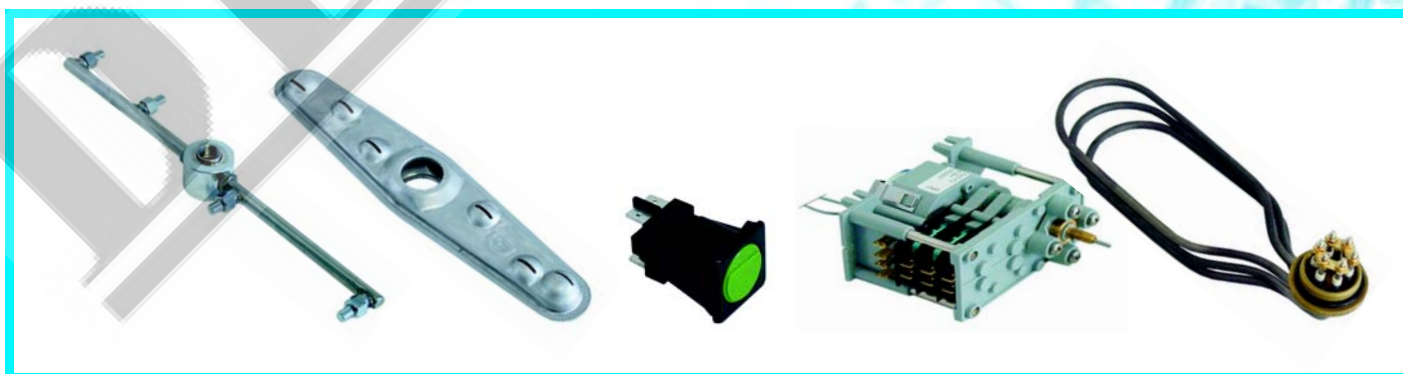

DeoMatic Horeca-Industrie s.p.r.l.
Pièces détachées pour Cuisines Industrielles
34 rue des alliés Bongenotenstraat 34
1190 Bruxelles 1190 Brussel

Tel. : 02 343 97 64
Fax : 02 343 90 31
deomatic@skynet.be
www.deomatic.be

Partner of  **GEV GROUP**

DEONLATIC



Systèmes de lavage et de rinçage

Page 4



Divers et réservoirs d'air

Page 6

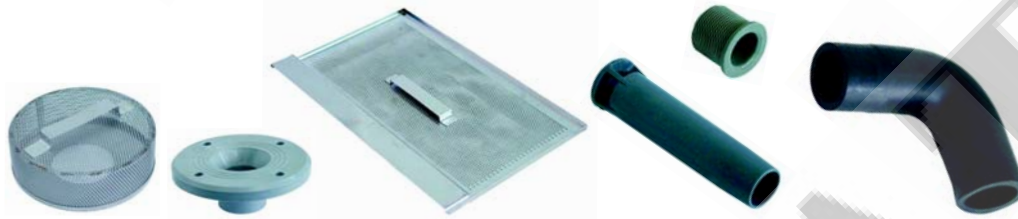

Systèmes de vidange et de filtre

Page 8



Mécanique de porte et de capot

Page 9



Composants électriques

Page 10



Technique de dosage

Page 12



Résistances et surchauffeurs

Page 13



Pompes et pièces de rechange

Page 14

Systèmes de lavage et de rinçage



Fig.	Réf.	Description	Modèle	Réf. C.
1	506077	bras de rinçage/ en bas	S200	0200801
2	506064	bras de rinçage/ en bas	Minibar, Super QS, S280, 040F, GS4	0200296
3	506062	bras de rinçage/ en bas	045F, S510	0200288
4	506061	bras de rinçage/ en bas	050F, GS6, 086F, 01F, F85, F92, L20, L21, 014, 24L, L25	0200287
5	506078	bras de rinçage/ en bas	P700	0200802

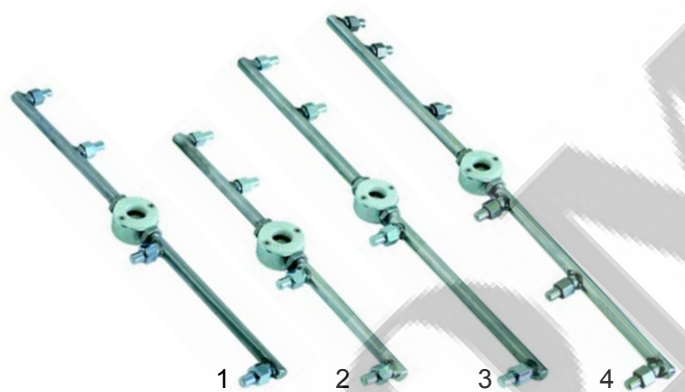

Fig.	Réf.	Description	Modèle	Réf. C.
1	506215	bras de rinçage/ en haut	S200, Minibar, Super PS, S280, 040F	0200806
2	506216	bras de rinçage/ en haut	045F, S510	0200803
3	506079	bras de rinçage/ en haut	050F, 075F, 01F, F85, F92, L20, L21, L25, 015, 24L	0200804
4	506080	bras de rinçage/ en haut	P700	0200805

Sous-ensembles

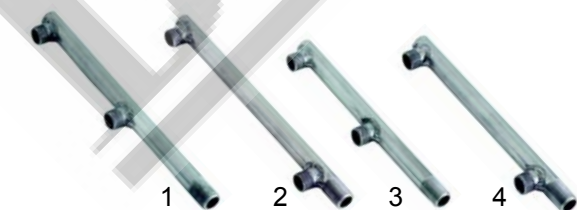

Fig.	Réf.	Description	Modèle	Réf. C.
1	506006	bras de rinçage, 175mm, gauche		0200017
2	506005	bras de rinçage, 175mm, droit		0200016
3	506004	bras de rinçage, 150mm, gauche		0200015
4	506003	bras de rinçage, 150mm, droit		0200014



Fig.	Réf.	Description	Modèle	Réf. C.
1	506068	bras de rinçage, 200mm, gauche		0200371
2	506067	bras de rinçage, 200mm, droit		0200370
3	506002	bras de rinçage, 235mm, gauche		0200013
4	506001	bras de rinçage, 235mm, droit		0200012

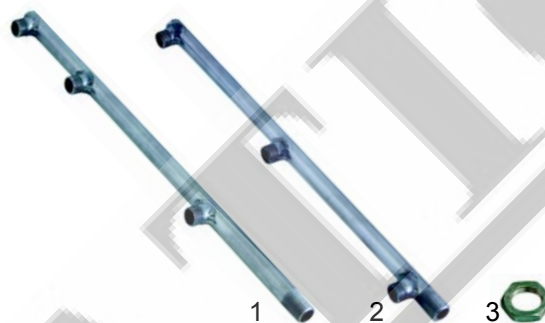

Fig.	Réf.	Description	Modèle	Réf. C.
1	506070	bras de rinçage, 300mm, gauche		0200373
2	506069	bras de rinçage, 300mm, droit		0200372
3	521131	écrou, M12 x 1		0200205



Fig.	Réf.	Description	Modèle	Réf. C.
1	506089	gicleur rinçage, 1,2mm		0201164
1	506090	gicleur rinçage, 1,5mm (extérieur)		0201165
2	506065	joint torique		0200303
3	506075	raccord olive		0200608
4	506049	gicleur rinçage, 1/8", 1,1mm	GS4, GS6	0200186
4	506050	gicleur rinçage, 1/8", 1,8mm	075F, 015 (à 9/98)	0200187



Fig.	Réf.	Description	Modèle	Réf. C.
1	506037	gicleur rinçage, 1/8", 1,1mm		0200132
2	506057	étrier pour buse de rinçage	GS6	0200250
3	506054	joint torique		0200239
4	506066	pipe alimentation		0200315



Fig.	Réf.	Description	Modèle	Réf. C.
1	506191	douille (téflon), intérieur, 16,2mm		0800498
2	506088	partie centrale tourniquet rinçage		0201151
3	506192	douille (téflon), intérieur, 13,3mm	universel	0800499
4	506172	vis fixation bras		0800130



Fig.	Réf.	Description	Modèle	Réf. C.
1	506019	partie centrale tourniquet rinçage	universel	0200086
2	506012	axe de bras de rinçage (inox)		0200038
3	506193	douille (téflon)		0800500
4	506087	partie centrale tourniquet rinçage	P700 (en bas)	0201150
5	506174	douille (téflon)		0800175
6	506084	axe de bras de rinçage		0201001



Fig.	Réf.	Description	Modèle	Réf. C.
1	506020	bras rinçage inox	S200, Minibar, Super QS, S280, 040F, 045F, S510	0200096
1	506104	bras rinçage inox	015, 24L, L25	0201836
2	506086	axe de bras de rinçage	GS4 universel	0201002 201003



Fig.	Réf.	Description	Modèle	Réf. C.
1	506042	joint, 27 x 17 x 2		0200171
2	506024	écrou		0200101
3	101273	olive, Ø12mm		0200182
4	506048	raccord olive		0200181

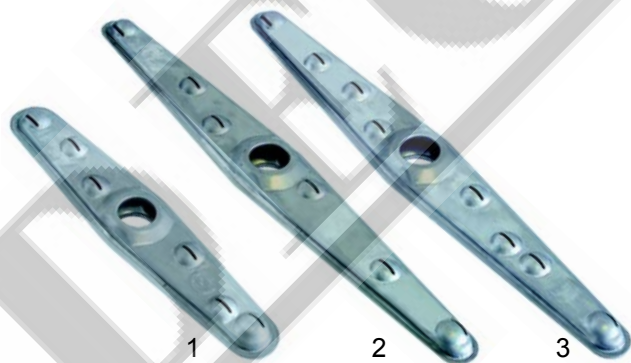

Fig.	Réf.	Description	Modèle	Réf. C.
1	506155	bras de lavage	Minibar, S200, Super QS, S280, 040F, 045F, S510, GS4, en haut: 050F, 075F, 01F, F82, F92, L20, L21	0500505
2	506153	bras de lavage	en bas: 050F, 075F, 01F, F8L, F92, L20, L21, L25, 015, 24L, GS6	0500500
3	506154	bras de lavage	015, 24L, L25 (en haut), P700	0500501



Fig.	Réf.	Description	Modèle	Réf. C.
1	506117	coussinet bras lavage/ bas	S200, Minibar, Super QS, S280, 040F, 045F, S510, GS4, GS6, L20, L21 (en haut), P700 (en haut + en bas)	0202103
2	506116	coussinet bras lavage/ bas	050F, 075F, 01F, F82, F92, L20, L21	0202101
3	506164	rondelle téflon/ bas, 57 x 41 x 2mm	universel	0800052
4	506118	coussinet bras lavage/ haut		0202120
5	506198	rondelle nylon/ haut, 50 x 18,5 x 2mm	050F, 075F, 01F, F82, F92, 015, 24C, L25	0800686
6	506203	rondelle inox/ haut, 50 x 22,2mm		0800901
6	506161	rondelle inox/ haut, 50 x 18,2mm	L20, L21, P70	0800030
6	506204	rondelle inox/ bas		0800902

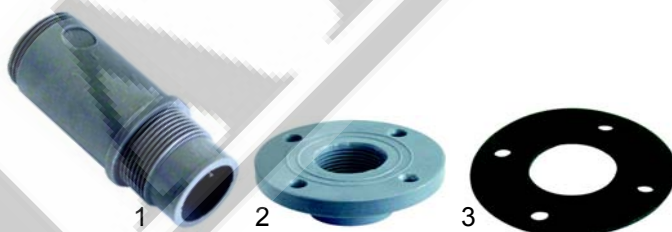

Fig.	Réf.	Description	Modèle	Réf. C.
1	506033	colonne de lavage		0200126
2	506094	support	050F, 075F, 01F, F85, F92	0201458
3	506021	joint		0200097



Fig.	Réf.	Description	Modèle	Réf. C.
1	506092	colonne de lavage	S200, Super QS, S280, Minibar, 040F, 045F, S510	0201451



Fig.	Réf.	Description	Modèle	Réf. C.
1	506015	joint torique	S200, Minibar, Super QS, S280, 040F, 045F, S510	0200056
2	506018	écrou		0200080
3	506121	joint/ colonne de lavage	GS4, GS6	0208153
4	506018	écrou		0200080



Fig.	Réf.	Description	Modèle	Réf. C.
1	506030	flasque, 1 1/4"	L20, L21	0200118
2	506021	joint		0200097
3	506094	flasque		0201458

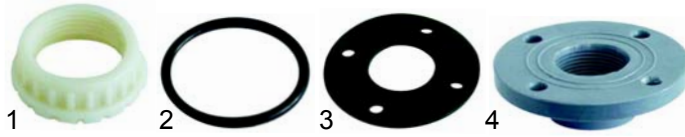

Fig.	Réf.	Description	Modèle	Réf. C.
1	506018	écrou, 1 1/4"	015, 24C, L25	0200080
2	506015	joint torique		0200056
3	506021	joint		0200097
4	506094	flasque, 1 1/4"		0201458

Divers



Fig.	Réf.	Description	Modèle	Réf. C.
1	506042	joint, 27 x 17 x 2mm		0200171
2	506024	écrou, 3/8" (inox)		0200101
3	101273	olive, 12mm		0200182
4	506048	raccord olive, 3/8", 12mm		0200181



Fig.	Réf.	Description	Modèle	Réf. C.
1	506058	olive, 12mm (téflon)		0200268
2	506013	réduction, 3/8" - 1/4" (inox)		0200040
3	506073	clapet anti-retour		0200426



Fig.	Réf.	Description	Modèle	Réf. C.
1	506196	raccord olive	015, 24L, L25,	0800673
2	506058	olive	075F	0200268



Fig.	Réf.	Description	Modèle	Réf. C.
1	506014	raccord tuyau, 3/4" - 25mm		0200049
2	506126	raccord tuyau, 3/4" - 25mm		0221313

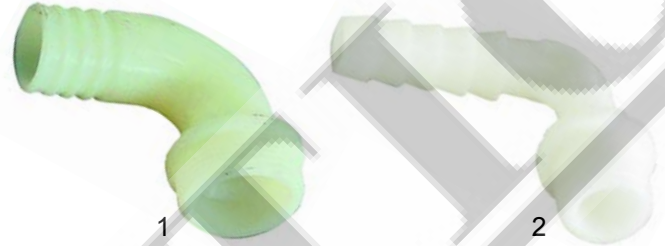

Fig.	Réf.	Description	Modèle	Réf. C.
1	506127	raccord tuyau, 1 1/4" - 30mm		0221314
2	506125	raccord tuyau, 3/8" - 12mm		0221310

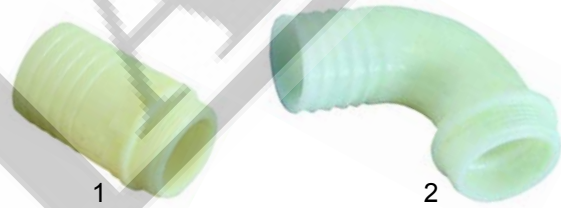

Fig.	Réf.	Description	Modèle	Réf. C.
1	506123	raccord tuyau, 1 1/2" - 50mm		0221305
2	506129	raccord tuyau, 1 1/2" - 40mm		0221331

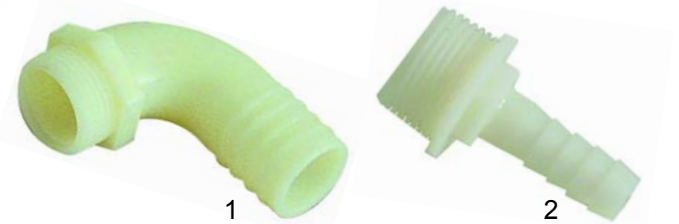

Fig.	Réf.	Description	Modèle	Réf. C.
1	506128	raccord tuyau, 1" - 32mm		0221315
2	506052	raccord tuyau, 3/4" - 12mm		0200231



Fig.	Réf.	Description	Modèle	Réf. C.
1	506081	1/2" - 16mm raccord		0200903
2	506082	1/2" - 15mm raccord		0200906
3	506083	réduction, 1 - 1/2"		0200932



Fig.	Réf.	Description	Modèle	Réf. C.
1	506125	raccord tuyau, 3/8" - 12mm		0221310
2	506042	joint		0200171
3	506132	écrou 3/8"		0300047

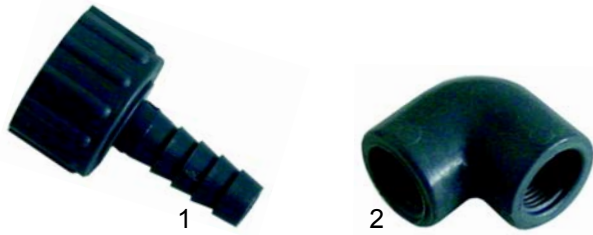

Fig.	Réf.	Description	Modèle	Réf. C.
1	506124	raccord tuyau		0221307
2	506041	PVC-angle, 3/8"		0200162

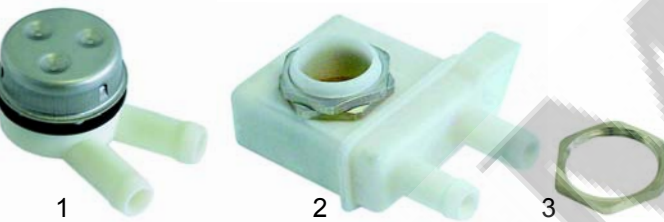

Fig.	Réf.	Description	Modèle	Réf. C.
1	516101	clapet anti vide		0500605
2	506210	clapet anti vide		0500602
3	506195	écrou		0800663



Fig.	Réf.	Description	Modèle	Réf. C.
1	506093	réservoir air		0201455
2	506063	joint		0200295
3	506076	connexion/ droit		0200638
4	506040	connexion		0200147
5	506200	ressort		0800712

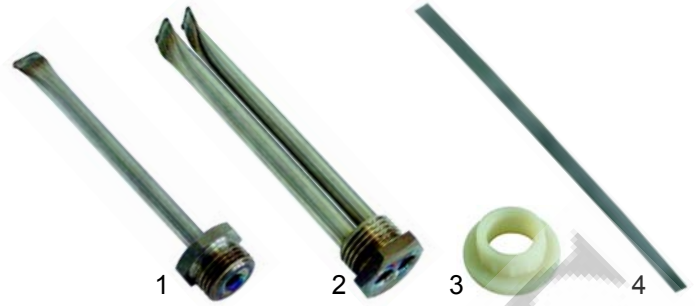

Fig.	Réf.	Description	Modèle	Réf. C.
1	506130	doigt de gant, 1-fois	universel	0300006
2	506059	doigt de gant, 2-fois	L25	0200270
3	506045	écrou (plastique)		0200176
4	506131	ressort		0300009

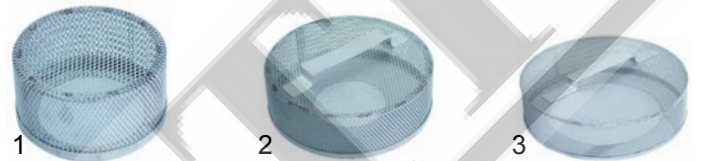

Fig.	Réf.	Description	Modèle	Réf. C.
1	506056	filtre, 100mm	S200, Minibar, Super QS, S280, S510	0200247
2	506009	filtre, 165mm	040F, 045F	0200024
3	506010	filtre, 215mm	050F, 075, 01F, F85, F92, L20, L21, P700	0200025



Fig.	Réf.	Description	Modèle	Réf. C.
1	506034	manchon d'aspiration	S200, Minibar, Super	0200127
2	506106	joint	QS, S280, S510, 040F, 045F	0208153
3	506018	écrou		0200080



Fig.	Réf.	Description	Modèle	Réf. C.
1	506129	manchon d'aspiration	050F, F85, F92, 075 (> 6"/98)	0221331
2	506123	manchon d'aspiration	075F, 01F (à 6"/98)	0221305
3	506016	écrou	050F, 075F,	0200058
4	506015	joint torique	01F (à 6"/98), F85, F92	0200056



Fig.	Réf.	Description	Modèle	Réf. C.
1	506028	flasque		0200115
2	506022	joint	01F (> 1"/98), L20, L21, P700	0200098
3	506029	manchon d'aspiration		0200116

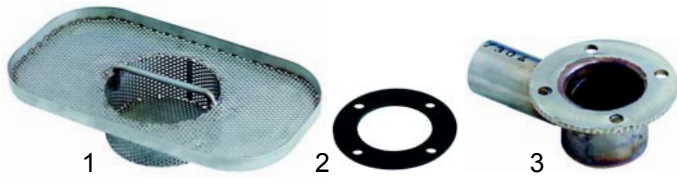

Fig.	Réf.	Description	Modèle	Réf. C.
1	506114	filtre	GS4, GS6	0202005
2	506106	joint		0208153
3	506096	manchon d'aspiration		0201470

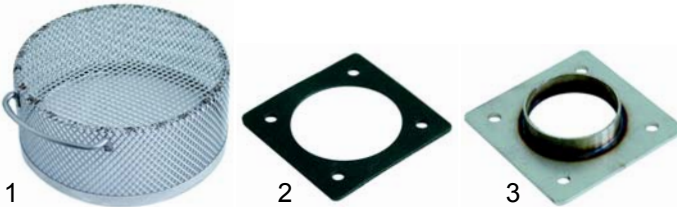

Fig.	Réf.	Description	Modèle	Réf. C.
1	506119	filtre	15, 24C, L25	0202209
2	506097	joint		0201506
3	506111	manchon d'aspiration		0201913

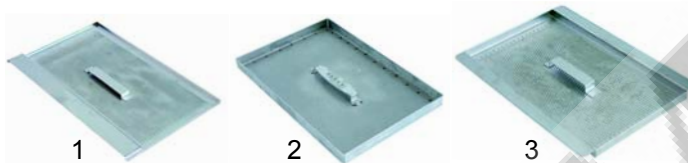

Fig.	Réf.	Description	Modèle	Réf. C.
1	506133	filtre cuve plat	01F, F92	0400151
2	506135	filtre cuve plat	L20, L21	0400153
3	506134	filtre cuve plat	014, 24L, L25	0400152

Systemes de vidange et de filtre

Tuyaux de trop plein

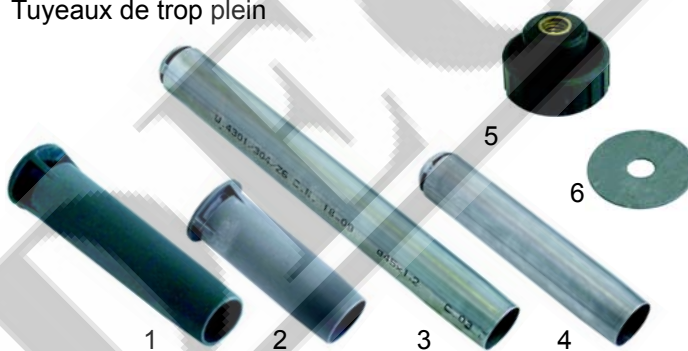

Fig.	Réf.	Description	Modèle	Réf. C.
1	506007	surverse trop plein, 100mm	S200, Minibar, Super QS, S280, 040F, 045F, S510	0200020
2	506047	surverse trop plein, 100mm	050F, 075F, F85, F92, L20, L21	0200180
3	506120	surverse trop plein, 45 x 340mm	015L, 24L, L25	0204003
4	506008	surverse trop plein, 45 x 200mm	P700	0200022
5	506146	écrou plat, M6		0500011
6	506205	rondelle (inox)		0800906



Fig.	Réf.	Description	Modèle	Réf. C.
1	506035	bonde de vidange	S200, Minibar,	0200128
2	506015	joint	Super QS, S280,	0200056
3	506018	écrou	040F, 045F, S510	0200080
4	506072	joint		0200403
5	506017	cornière d'assemblage		0200078



Fig.	Réf.	Description	Modèle	Réf. C.
1	506026	bonde de vidange	050F, 075F, 01F, F85,	0200113
2	506043	joint	F92, L20, L21, 015,	0200173
3	506027	écrou, 2"	L42, L25, P700	0200114
4	506072	joint, 2"		0200403
5	506017	cornière d'assemblage	050F, 075F, 01F, F85,	0200078
6	506122	connexion-pièces	F92, P700	0221302



Fig.	Réf.	Description	Modèle	Réf. C.
1	506016	écrou, 1 1/2"		0200058
2	506165	joint torique	075F (> 10/2000)	0800074
3	506129	cornière d'assemblage		0221331

Durites d'aspiration et de refoulement

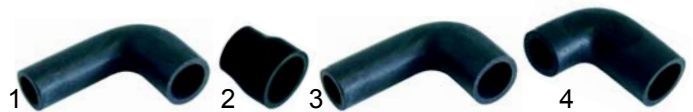

Fig.	Réf.	Description	Modèle	Réf. C.
1	506107	durite d'aspiration	Minibar, 040F, S510	0201904
2	506011	durite de refoulement		0200031
3	506107	durite d'aspiration	S200, Super QS, S280	0201904
4	506108	durite de refoulement		0201905

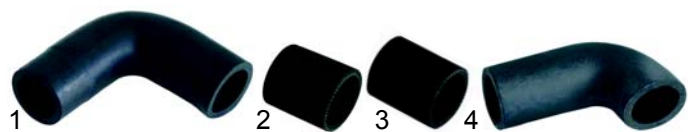

Fig.	Réf.	Description	Modèle	Réf. C.
1	506055	durite d'aspiration	045F	0200244
2	506031	durite de refoulement		0200119
3	506038	durite d'aspiration	050F, F85, F92	0200133
4	506110	durite de refoulement		02001907

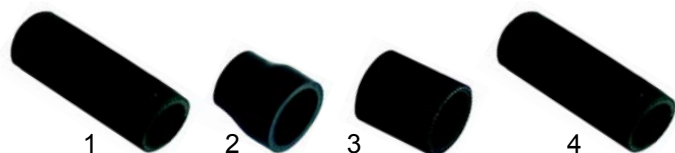

Fig.	Réf.	Description	Modèle	Réf. C.
1	506036	durite d'aspiration	GS4, GS6	0200131
2	506011	durite de refoulement		0200031
1	506053	durite d'aspiration	075F (à 6"/98), 04F, L20, L21	0200232
2	506060	durite d'aspiration	075F (> 6"/98)	0200274
3	506038	durite de refoulement/ en bas	075F, 01F, L20, L21	0200133
4	506036	durite de refoulement/ en haut	075F, 01F	0200131

Tuyaux de vidange



Fig.	Réf.	Description	Modèle	Réf. C.
1	506207	tuyau de vidange (pompe de vidange)	universel	0900006
2	506208	tuyau de vidange	S200	0900027
3	506214	tuyau de vidange	Minibar, Super QS, S280, 040F, 045F, 050F, S510, 075F, 01F, F85, F92, L20, L21, 015, 242, L25, P700	0200112



Fig.	Réf.	Description	Modèle	Réf. C.
1	506112	durite d'aspiration	15, 24C, L25	0201914
2	506113	durite de refoulement/ en bas		0201919
3	506036	durite de refoulement/ en haut		0200131

Mécanique de porte

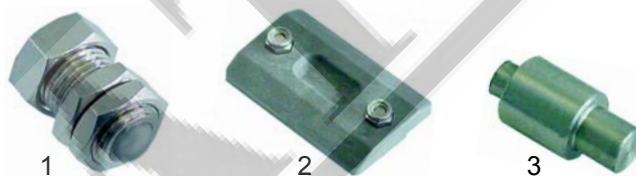

Fig.	Réf.	Description	Modèle	Réf. C.
1	506157	cliquet fermeture porte	S200, Minibar, Super QS, S280, 040F, 045F, 050F, S510, G54, G56, 075F, 01F, F85, F92, P700	0800006
2	506183	support		0800404
3	506168	roulement de porte		0800099



Fig.	Réf.	Description	Modèle	Réf. C.
1	506109	durite d'aspiration	P700	0201906
2	506032	durite de refoulement		0200122

Tuyaux, pompe de vidange

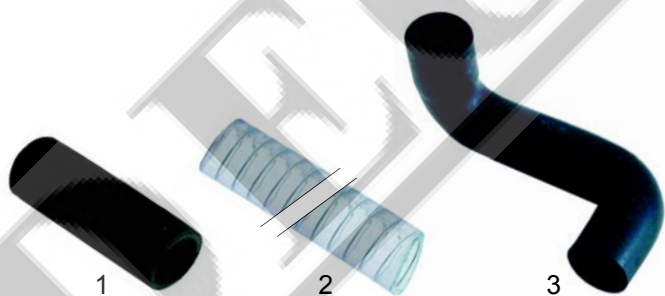

Fig.	Réf.	Description	Modèle	Réf. C.
1	506036	durite d'aspiration	Minibar, Super QS, S280, GS4, GS6	0200131
2	506074	durite d'aspiration	Super QS, S280, 075F, 01F (> 10"/00), I20, L20, L21, 015, 24C, L25	0200521
3	506209	durite d'aspiration	045F, 050F, 075F, 01F, F85, F92	0200213

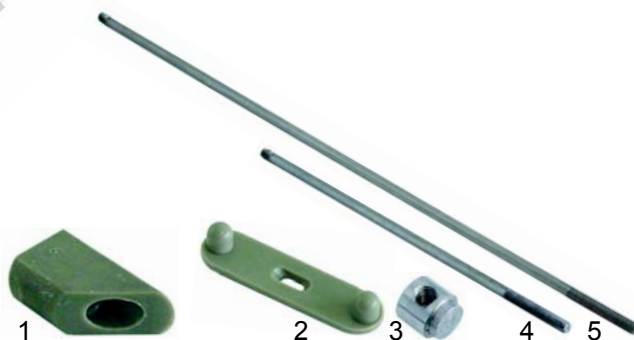

Fig.	Réf.	Description	Modèle	Réf. C.
1	506181	butée		0800402
2	506182	patte		0800403
3	506180	tourillon		0800401
4	506186	tirant porte	S200, Minibar, Super QS, GS4, P700	0800408
5	506179	tirant porte	S280, 040F, 045F, 050F, S510, G56, 075F, 01F, F85, F92, P700	0800400



Fig.	Réf.	Description	Modèle	Réf. C.
1	506185	butée	P700	0800406
2	506184	bille contact porte		0800405
3	506167	roulement de porte		0800098
4	506187	douille, M10		0800409

Mécanique de capot



Fig.	Réf.	Description	Modèle	Réf. C.
1	506178	coussinet tige de capot	L21, L25, O15, 24L	0800244
2	506188	douille		0800418
3	506023	joint		0200099



Fig.	Réf.	Description	Modèle	Réf. C.
1	506171	vis	L21	0800117
2	506206	vis	L25	0899999
3	506177	entretoise		0800242
4	506190	coussinet	L21, L25, 014, L42	0800497
5	506189	entretoise		0800420

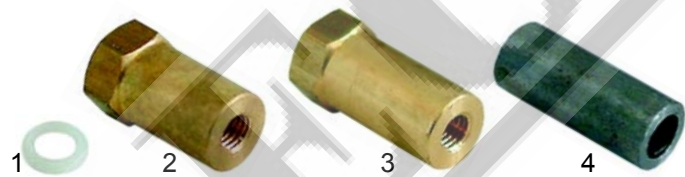

Fig.	Réf.	Description	Modèle	Réf. C.
1	506023	joint		0200099
2	506212	entretoise/ en haut	L20, L21, 015,	0800109
3	506213	entretoise/ en bas	L42, L25	0800110
4	506211	diffuseur		0800108

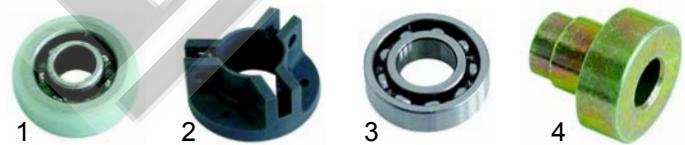

Fig.	Réf.	Description	Modèle	Réf. C.
1	506163	galets à rouleaux		0800048
2	506159	coussinet tige de capot	L20, L21,	0800020
3	506158	roulement à billes, articulation	L25, 015,	0800010
4	506170	support roulement	24L	0800115



Fig.	Réf.	Description	Modèle	Réf. C.
1	506199	ressort	L20, L21, L25, 015, 24L	0800711
2	506147	poignée	L20	0500049

Composants électriques

Interrupteur



Fig.	Réf.	Description	Modèle	Réf. C.
1	345565	interrupteur principal, 2-pôle, contact fermé	universel	0301000
2	345497	interrupteur principal (pompe de vidange), 2-pôle, contact inverseur	Minibar, S280, Super QS, 045F, 050F, 075F, 01F, F85, F92, L20, L21, L25, 015, 24L	
3	345499	interrupteur principal/ pompe de vidange, 2-pôle, 1W + 1S	Super QS, S280, 040F, 045F, 050F, S510	0301004



Fig.	Réf.	Description	Modèle	Réf. C.
1	345498	poussoir, 2-pôles, 2 gonds contact (adoucisseur)	GS4	0301101
2	345226	poussoir, 1-pôle, 1 contact fermé	S200, Minibar, Super QS, S280, 040F, 045F, 050F, S510, GS4, GS6	0301100
3	359434	voyant/ vert, 230V	universel	0300284

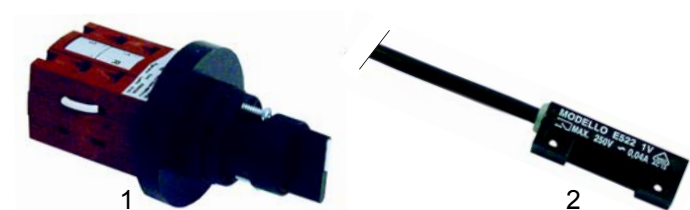

Fig.	Réf.	Description	Modèle	Réf. C.
1	345564	sélecteur programme	015, 24L, L25	0300206
2	345504	micro-rupteur magnétique	universel	0300138

Programmateurs

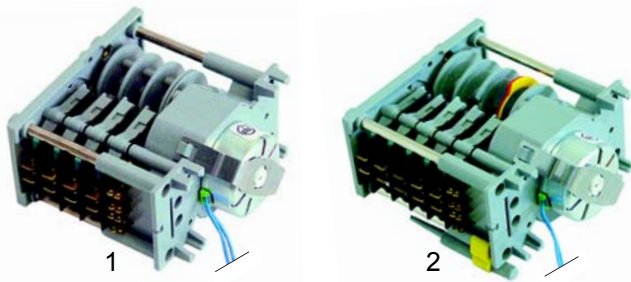

Fig.	Réf.	Description	Modèle	Réf. C.
1	360256	120°, 4 cames	S200, Minibar, Super QS, S280, 040F, 050F, S510	0300143
2	360258	180°, 5 cames	GS4, GS6	0300801



Fig.	Réf.	Description	Modèle	Réf. C.
1	360255	360°, 3 cames, touche de répétition	045F, 075F, 01F, F85, F92, L20, L21	0300807
2	110905	manette		0300049

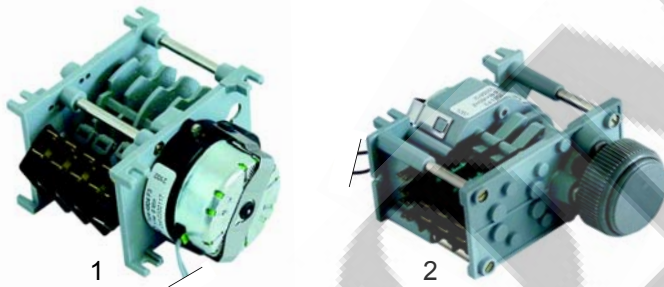

Fig.	Réf.	Description	Modèle	Réf. C.
1	360257	360°, 4 cames	015, 24L, L25	0300117
2	360259	360°, 3 cames, touche de répétition	P700	0300812

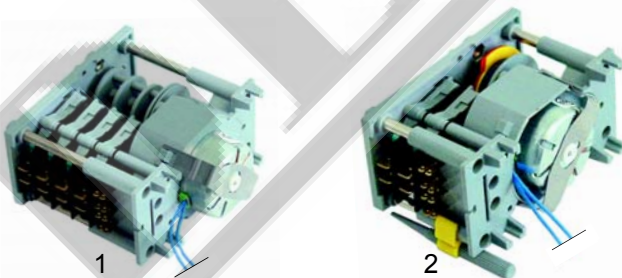

Fig.	Réf.	Description	Modèle	Réf. C.
1	360253	20 min., programmeur	Super QS, S280, 040F, 050F	0300297
2	360254	60 sec., 2 cames, doseur pour nettoyeur		0300085

Pressostats

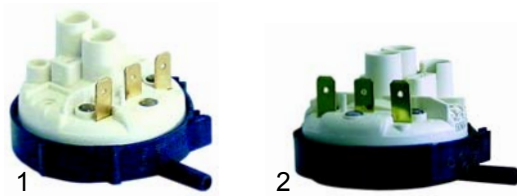

Fig.	Réf.	Description	Modèle	Réf. C.
1	541165	60/30	universel	0300026
2	541011	110/70	015, 24L, L25, P700	0301501

Relais

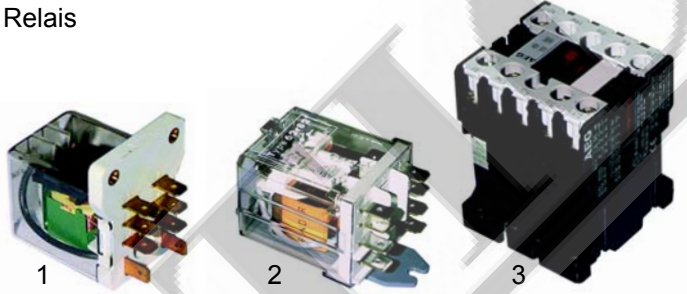

Fig.	Réf.	Description	Modèle	Réf. C.
1	380310	relais, 2 contact inverseur, 230V	S200, Minibar, Super QS, S280, 040F, 045F, 050F, S510, GS4, 075F, 01F, F85, F92, L20, L21	0300063
2	380139	relais, 2 contact inverseur, 230V		0301745
3	380238	contacteur, 3 contact à fermeture + 1 contact à fermeture, 230V	045F, 075F, 01F, F85, F92, L20, L21, P700	0300058

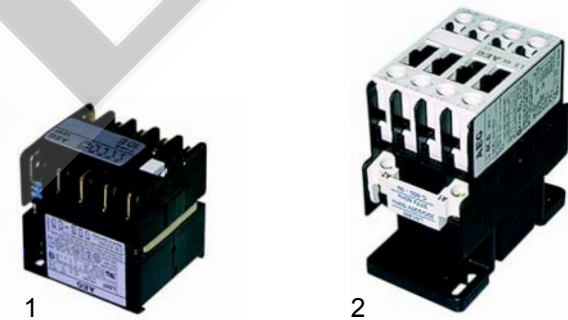

Fig.	Réf.	Description	Modèle	Réf. C.
1	380237	contacteur, 3 contact à fermeture + 1 contact ouvert, 230V	015, 24L, L25	0300392
1	380236	contacteur, 3 contact à fermeture + 1 contact à fermeture, 230V	GS4, GS6	0300059
2	380244	contacteur, 3 S + 1 contact à fermeture, 230V	GS4, 015, 24L, L25	0300390

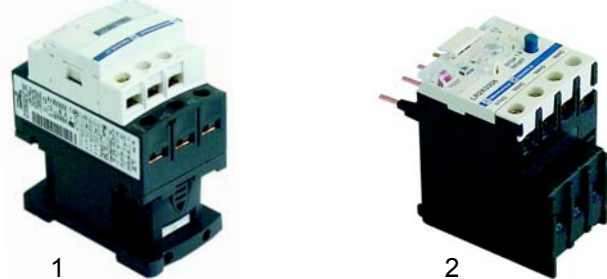

Fig.	Réf.	Description	Modèle	Réf. C.
1	380479	contacteur, 3 S + 1 S / 1 contact ouvert, 230V	015, 24L, L25	0300050
2	380450	relais thermique, 1,5 - 2,5A	015, 24L, L25	0300198
2	380452	relais thermique, 3,8 - 6,3A	P700	0300324

Thermostats

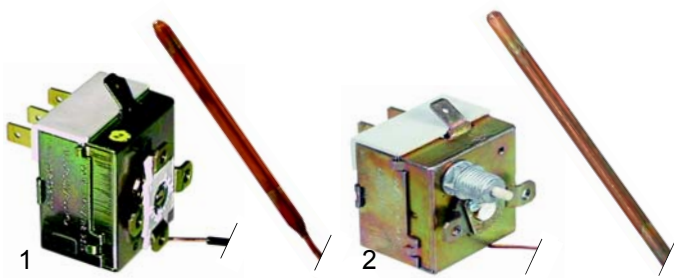

Fig.	Réf.	Description	Modèle	Réf. C.
1	390460	30 - 90°C, 2000mm/ capillaire	universel	0300005
2	390458	thermostat de sécurité, 110°C		0300004



Fig.	Réf.	Description	Modèle	Réf. C.
1	506130	doigt de gant, 1-fois	universel	0300006
2	506059	doigt de gant, 2-fois	L25	0200270
3	506025	joint		0200110
4	506045	écrou (inox)	universel	0200176
5	506194	écrou, MS - VN		0800655

Thermomètre

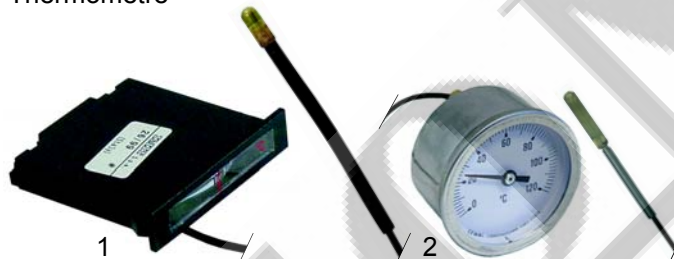

Fig.	Réf.	Description	Modèle	Réf. C.
1	541305	11,5 x 62,5mm, 1000mm/ capillaire	Super QS, S280, GS4, GS6	0500008
2	541065		F92, L25	0500009

Divers



Fig.	Réf.	Description	Modèle	Réf. C.
1	365046	filtre arrivée		0300090
2	365017	condensateur, 5µF		0300105
2	365012	condensateur, 6,3µF		0300110
2	365015	condensateur, 10µF		0300106

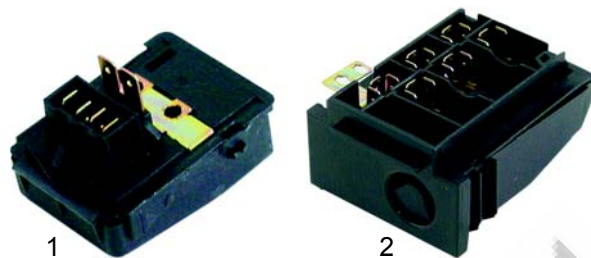

Fig.	Réf.	Description	Modèle	Réf. C.
1	550670	bornier, 1 phase	universel	0300750
2	550671	bornier, 3 phase		0300751

Electrovannes

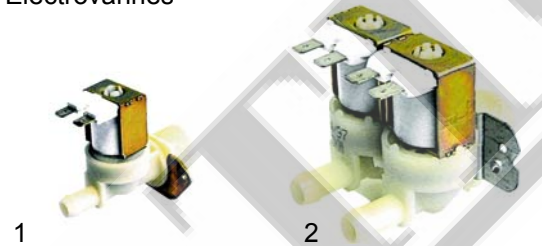

Fig.	Réf.	Description	Modèle	Réf. C.
1	370017	1 voie, 230V	S200, 040F, 045F, 050F, 075F, 01F, F85, F92, L20, L21, 015, 24L, L25	0300025
2	370021	2 voies	Minibar, Super QS, S280, S510, GS4, GS6, P700	0300056

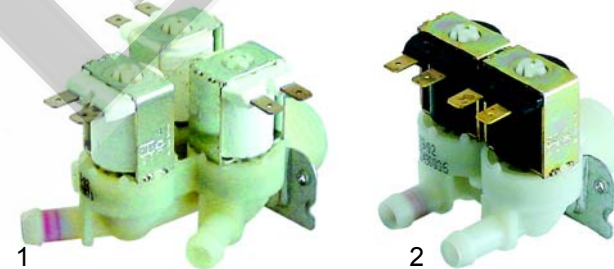

Fig.	Réf.	Description	Modèle	Réf. C.
1	370242	3 voies, 230V, avec réduction	Super QS, S280, S510	0300096
2	370241	2 voies, 230V, avec réduction	040F, 045F, 050F, 075F, 01F, F85, F92	0301149

Technique de dosage



Fig.	Réf.	Description	Modèle	Réf. C.
1	361299	doseur, 2,4L/h		0500058, 0500063
2	361359	tuyau		0500072

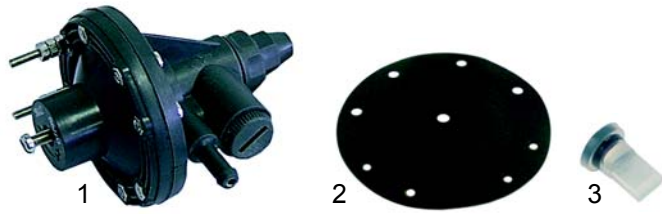

Fig.	Réf.	Description	Modèle	Réf. C.
1	361015	doseur produit de rinçage		0599999
2	361132	membrane		0200428
3	510298	embout		0200425



Fig.	Réf.	Description	Modèle	Réf. C.
1	506149	doseur pour nettoyeur		0500059



Fig.	Réf.	Description	Modèle	Réf. C.
1	506150	raccord entrée		0500090
2	506046	joint		0200178
3	506166	écrou, M10		0800091
4	506151	écrou/ raccord tuyau		0500091



Fig.	Réf.	Description	Modèle	Réf. C.
1	361062	filtre réservoir		0200443
2	506095	filtre réservoir avec embout		0201460

Résistance



Fig.	Réf.	Description	Modèle	Réf. C.
1	416227	1000W, 230V	S200, GS4, GS6	0303044
2	416228	2000W, 230V	Minibar, Super QS, S280, 040F, 050F, S510, 075F, 01F, F82, F92	0300067
3	506046	joint		0200178
4	506162	écrou		0800045



Fig.	Réf.	Description	Modèle	Réf. C.
1	416225	2400W, 3 x 230V, 1 1/4"	L20, L21	0303042
2	416226	4500W, 3 x 230V, 1 1/4"	P700	0300022
3	506015	joint		0200056
4	506018	écrou, 1 1/4"		0200080



Fig.	Réf.	Description	Modèle	Réf. C.
1	416229	2400W, 2 x 230V	S200, Minibar, Super QS, S280, 040F, GS4	0303001
2	416230	3000W, 3 x 230V	045F, 050F, S510, 015, 24L, L25	0300011
3	416232	6000W, 3 x 230V	GS6, 075F, 01F, F85, F92, L20, L21, 015, 24L, L25, P700	0300012



Fig.	Réf.	Description	Modèle	Réf. C.
1	416231	4500W, 3 x 230V	F85, F92	0300002
2	416233	9000W, 3 x 230V	015, 24L, L25	0300299

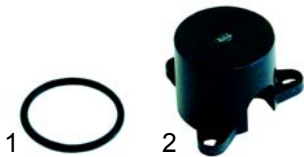

Fig.	Réf.	Description	Modèle	Réf. C.
1	510409	joint torique/ joint		0200041
2	520258	capot		0301112

Pompes

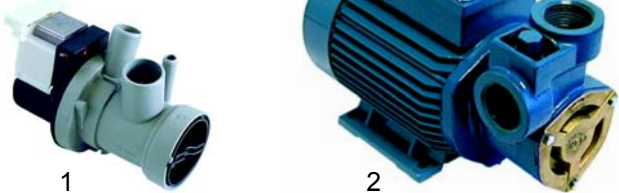

Fig.	Réf.	Description	Modèle	Réf. C.
1	500354	pompe de vidange	universel	0300068
2	500060	électropompe rinçage		0300361



Fig.	Réf.	Description	Modèle	Réf. C.
1	500353	ZF115, 0,1PS, 230V	S200, Minibar, Super QS, S280	0300252
2	500352	ZF130, 0,25PS, 230V	040F, S510, GS4, GS6	0300373
3	500375		GS6	0300245



Pompe		1 Turbine		2 Joint d'étanchéité		3 Joint de boîtier		4 Flasque de pompe		5 Condensateur	
Réf.	Réf. C.	Réf.	Réf. C.	Réf.	Réf. C.	Réf.	Réf. C.	Réf.	Réf. C.	Réf.	Réf. C.
500353	0300252	521223	0209804	510703	0200397	521704	0209905	521519	0200595	365017	
500352	0300373	521224	0209819	510703	0200397	521704	0209905	521519	0200595	365012	
500375	0300245	521270	0209820	510692		521702		521507			
500016	0300024	510358	0200228	510693	0200242	510399	0200241	510950	0200271	365015	
500355	0301204	521226		510692		521704		521521		365013	
500323	0300310	510599	-	510693	0209707	510551	0200290	510502	0200277	-	-

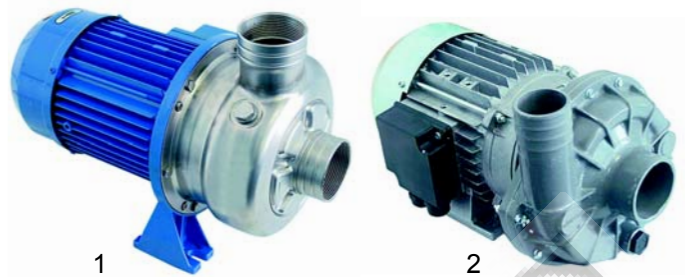

Fig.	Réf.	Description	Modèle	Réf. C.
1	500357	DW0150, 1,5PS, 400V	015/ 24L, L25	0301254
2	500323	M227, 2,7PS, 400V	P700	0300310

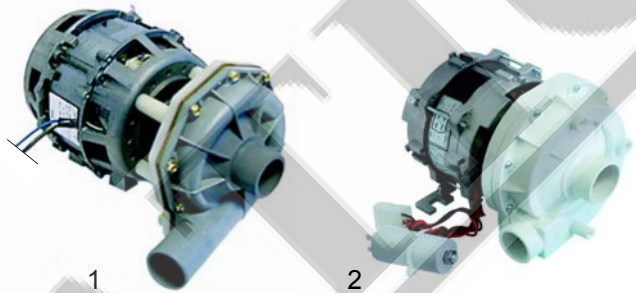

Fig.	Réf.	Description	Modèle	Réf. C.
1	500016	0,60PS, 230V	045F, 050F, 075F, 0,1F, F85,	0300024, 0301203
2	500355	ZF320, 0,85PS, 230V	F92, L20, L21	0301204

Notes

DEOMATIC

DeoMatic Horeca-Industrie s.p.r.l.

Pièces détachées pour Cuisines Industrielles

34 rue des alliés

Bongenotenstraat 34

1190 Bruxelles

1190 Brussel

Tel. : 02 343 97 64

Fax : 02 343 90 31

deomatic@skynet.be

www.deomatic.be

Partner of  **GEV GROUP**

Réf.: P090301701

